

# **NAD** SERVICE **MANUAL**

930

For Service Manuals Contact  
MAURITRON TECHNICAL SERVICES  
8 Cherry Tree Rd, Chinnor  
Oxon OX9 4QY  
Tel: 01844-351694 Fax: 01844-352554  
Email: enquiries@mauritron.co.uk

# 4155

## AM/FM STEREO TUNER

# NAD 4155 SERVICE MANUAL

NOTE: This manual covers all versions.

A: U.S.A.  
A1: Canada  
B: U.K.  
B1: Australia  
C: EUROPE and others  
C1: W-Germany

TABLE OF CONTENTS	PAGE
LOCATION MAP	2
SPECIFICATION	3
INTERNAL VIEW	4
SUGGESTED INSTRUMENTATION HOOKUP	5
FM ALIGNMENTS	6-9
AM ALIGNMENTS	10-11
WIRING DIAGRAM	12-13
P.C.B. LAYOUT DIAGRAM	14-15
SCHEMATIC DIAGRAM	16-17
EXPLODED VIEW PARTS LIST	18-19
EXPLODED VIEW	20
ELECTRICAL PARTS LIST	21-23

For Service Manuals Contact  
**MAURITRON TECHNICAL SERVICES**  
8 Cherry Tree Rd, Chinnor  
Oxon OX9 4QY  
Tel:- 01844-351694 Fax:- 01844-352554  
Email:- enquiries@mauritron.co.uk

**REAR PANEL**

- 1. AM rod antenna.
- 2. Antenna terminals.
- 3. Output jacks.
- 4. Output level control.
- 5. AC line cord.

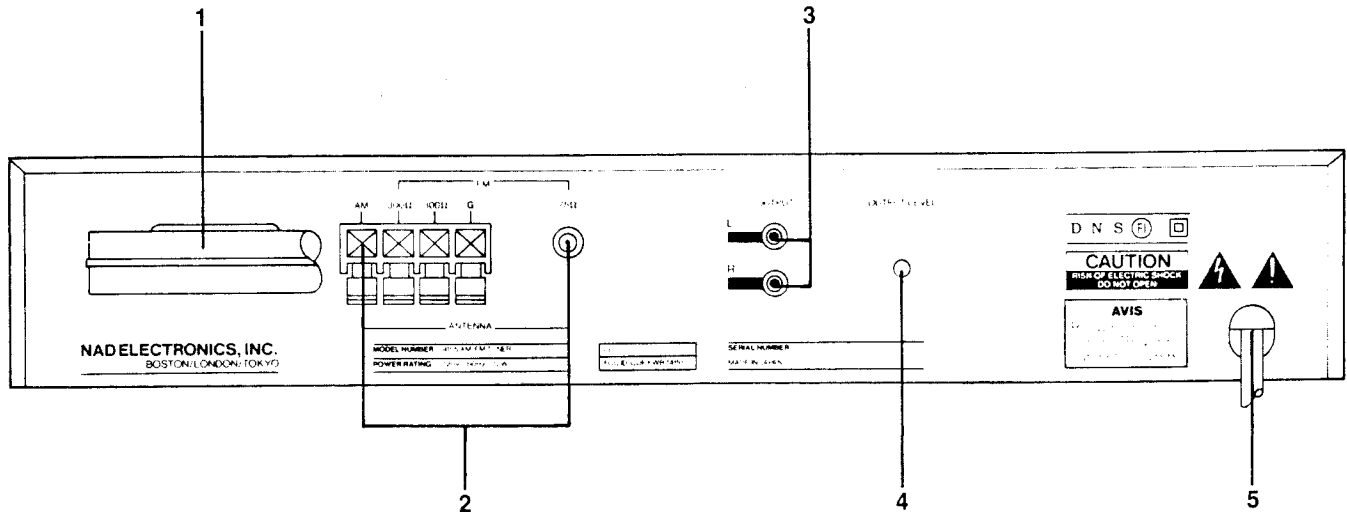

**CAUTION**  
RISK OF ELECTRIC SHOCK  
DO NOT OPEN

CAUTION TO REDUCE THE RISK OF ELECTRIC SHOCK DO NOT REMOVE COVER (OR BACK). NO USER-SERVICEABLE PARTS INSIDE. REFER SERVICING TO QUALIFIED SERVICE PERSONNEL.

**FRONT PANEL**

- 1. Power.
- 2. Mono.
- 3. FM Mute.
- 4. Dyn Sep Defeat.
- 5. Tuning Display.
- 6. FM Stereo indicator.
- 7. Pre-sets.
- 8. Enter.
- 9. AM/FM.
- 10. Up/Down Tuning.
- 11. Search.

For Service Manuals Contact  
**MAURITRON TECHNICAL SERVICES**  
8 Cherry Tree Rd, Chinnor  
Oxon OX9 4QY  
Tel: 01844-351694 Fax: 01844-352554  
Email: enquiries@mauritron.co.uk

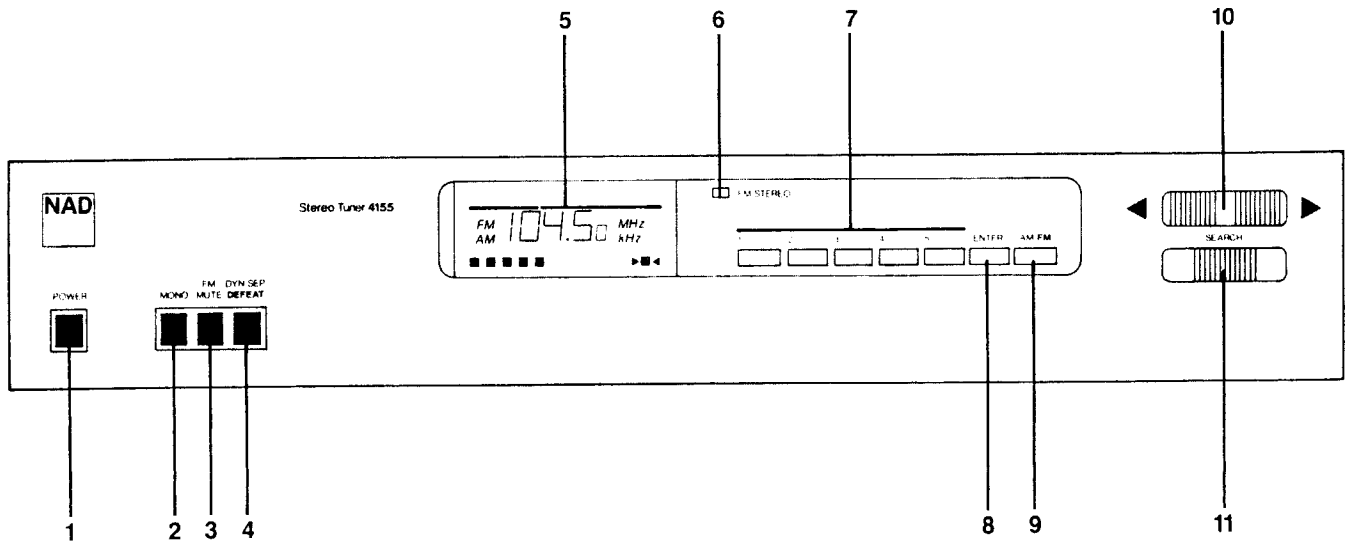

 The lightning flash with arrowhead, within an equilateral triangle, is intended to alert the user of the presence of uninsulated "dangerous voltage" within the product's enclosure; that may be of sufficient magnitude to constitute a risk of electric shock to persons.

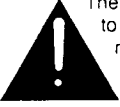
 The exclamation point within an equilateral triangle is intended to alert the user of the presence of important operating and maintenance (servicing) instructions in the literature accompanying the appliance.

# SPECIFICATIONS

NOTE: Specifications are measured in accordance with ANSI-IEEE Standard 185 (1975) (IHF T-200). Sensitivity is measured via 75 ohm coaxial input and converted to equivalent 300 ohm values.

## FM Tuner Section

Input sensitivity		All versions except USA.	USA version only.
	Mono, -30 dB THD + N:	50 $\mu$ sec. deemphasis	75 $\mu$ sec.
		10.3 dBf.	9.8 dBf.
		(1.8 $\mu$ V/300 ohms)	(1.7 $\mu$ V/300 ohms)
	Mono, 50 dB S/N:	15.8 dBf.	13.2 dBf.
		(3.2 $\mu$ V)	(2.5 $\mu$ V)
	Stereo, 50 dB S/N:	33.2 dBf.	32 dBf.
		(25 $\mu$ V)	(22 $\mu$ V)
	Stereo, 60 dB S/N:	43.1 dBf.	42 dBf.
		(78 $\mu$ V)	(70 $\mu$ V)
Capture ratio at 25, 45 & 65 dBf.		< 1.5 dB.	
AM rejection.		> 65 dB.	
Selectivity,	Alternate channel:	70 dB.	
	Adjacent channel:	8 dB.	
Image rejection.		85 dB.	
R. F. intermodulation.		70 dB.	
I. F. rejection.		90 dB.	
SCA rejection.		70 dB.	
Subcarrier suppression (19 + 38 kHz).		60 dB.	
THD at 100 % modulation,		1 kHz	100 Hz - 6 kHz
	Mono:	0.09 %	0.2 %
	Stereo:	0.09 %	0.3 %
Signal to noise ratio, A-weighted, 65 dBf.	Mono:	82 dB.	
	Stereo:	75 dB.	
		(typ. 80 dB at 75 dBf)	
Frequency response, 30 - 15 kHz.		$\pm$ 0.5 dB.	
Stereo separation (Dyn Sep off),	1 kHz:	50 dB.	
	30 Hz - 10 kHz:	40 dB.	

## AM Tuner Section

Usable sensitivity.		300 $\mu$ V/meter.
Selectivity.		35 dB.
Image rejection.		50 dB.
I. F. rejection.		50 dB.

For Service Manuals Contact  
**MAURITRON TECHNICAL SERVICES**  
 8 Cherry Tree Rd, Chinnor  
 Oxon OX9 4QY  
 Tel:- 01844-351694 Fax:- 01844-352554  
 Email:- enquiries@mauritron.co.uk

## Physical Specifications

Dimensions (width x height x depth)	42 x 7.6 x 20 cm. 16.5 x 3 x 8 in.
Net weight	3.81 Kg./8 lb. 6 oz.
Shipping weight	4.42 Kg./9 lb. 12 oz.
Power requirements	50/60 Hz at 110, 120, 220 or 240 VAC. 12 W.

# INTERNAL VIEW

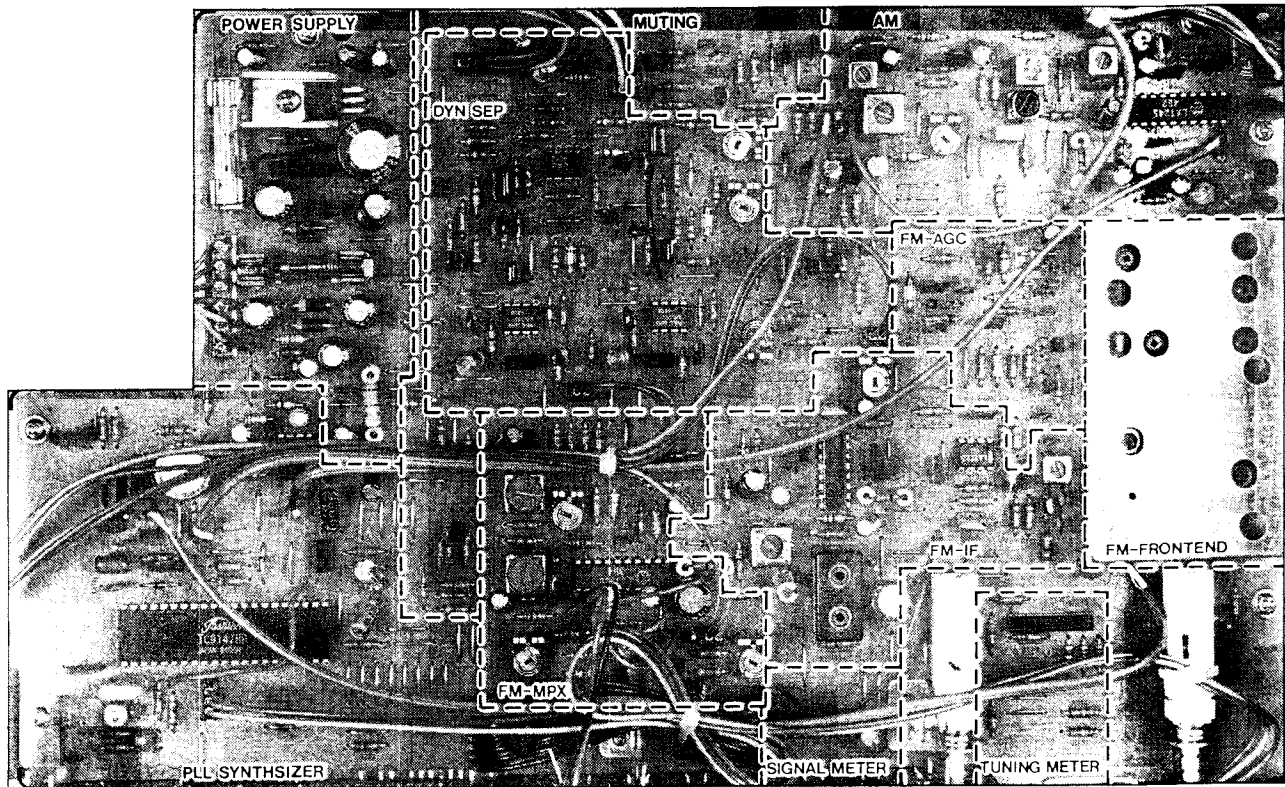

For Service Manuals Contact  
MAURITRON TECHNICAL SERVICES  
8 Cherry Tree Rd, Chinnor  
Oxon OX9 4QY  
Tel: 01844-351694 Fax: 01844-352554  
Email: enquiries@mauritron.co.uk

# SUGGESTED INSTRUMENTATION HOOKUP

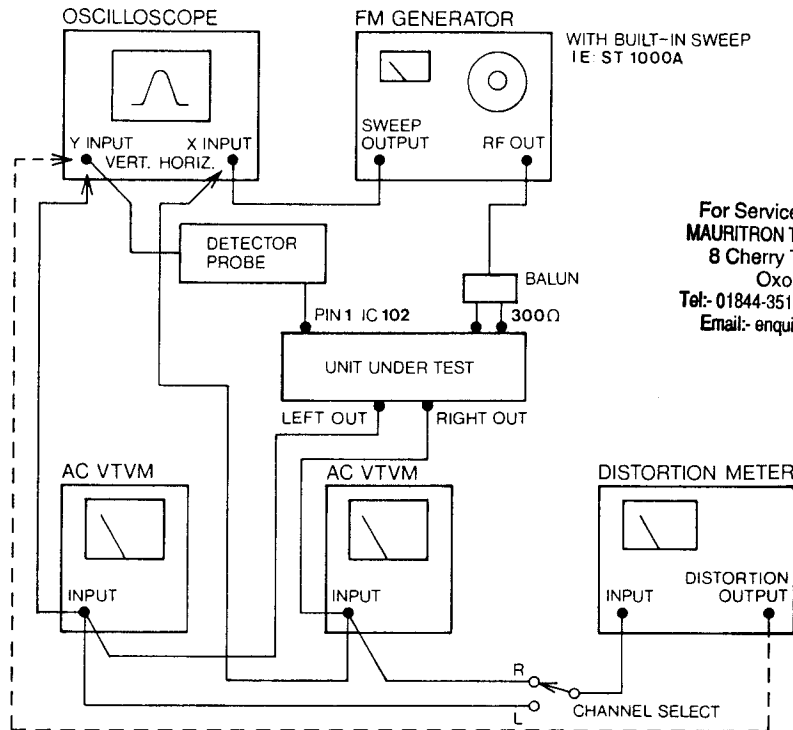
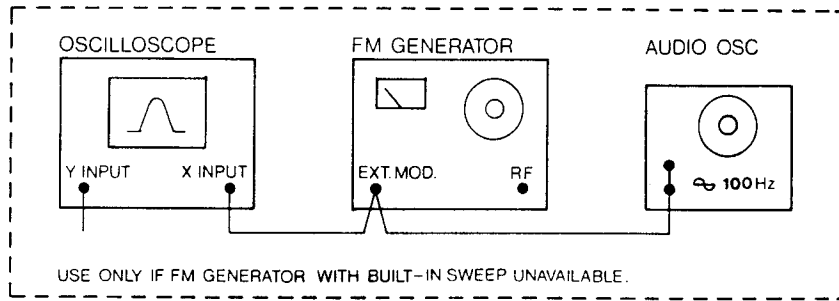

For Service Manuals Contact  
**MAURITRON TECHNICAL SERVICES**  
 8 Cherry Tree Rd, Chinnor  
 Oxon OX9 4QY  
 Tel: 01844-351694 Fax: 01844-352554  
 Email: enquiries@mauritron.co.uk

## SCHEMATIC DIAGRAM OF DETECTOR PROBE

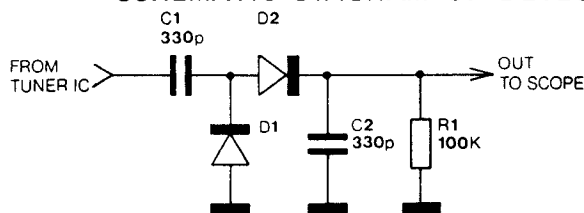

Diodes should be point-contact germanium; Some commonly available types are: OA80  
 OA81  
 AA119  
 1N60  
 1N34  
 1N22

## PICTORIAL DIAGRAM OF DETECTOR PROBE

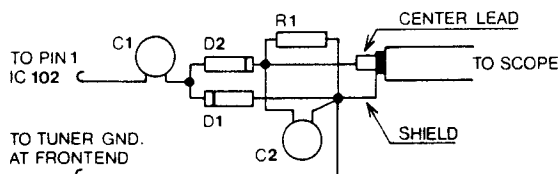

Keep leads as short as possible, to minimize stray signal pickup.

# FM ALIGNMENTS

## NECESSARY INSTRUMENTATION

FM GENERATOR (less than 0.05% THD)

STEREO GENERATOR (less than 0.05% THD, more than 50 dB sep.)

AUDIO GENERATOR (not necessary if FM generator has built in sweep; i.e., SOUND TECHNOLOGY ST 1000A and ST 1020A)

AC VTVM's (or one with a left/right switch)

THD ANALYZER (resolution less than 0.1%)

OSCILLOSCOPE (5mV or better sensitivity, X input capability)

FREQUENCY COUNTER

VOM or DMM (high impedance, must read in mV)

DETECTOR PROBE

## IMPORTANT

While all FM generator output levels hereafter are referred to the 300 ohm input, 75 ohm input can be used, but be aware of possible equipment groundloops and divide the RF output levels by 2.

Before alignments commence, release mute, mono and dyn sep defeat switches (out)..

## FRONTEND

Alignment of frontend should only be necessary after repair to frontend or crystal oscillator circuits (pin 2 and 3 on IC 110).

### A TUNING VOLTAGE (OSCILLATOR)

It is essential to check tuning voltage before aligning the rest of the frontend.

- 1 Connect DMM between ground and TP 102.
- 2 Tune to 108 MHz and adjust C 20 if voltage is incorrect.  
SPECIFICATION 24.7V  $\pm$  0.5V
- 3 Tune to 88 MHz and read voltage. Adjust L 6 if voltage is incorrect.  
SPECIFICATION 3.6V  $\pm$  0.5V
- 4 Repeat step 2 and 3 until readings are within tolerances.

For Service Manuals Contact  
MAURITRON TECHNICAL SERVICES  
8 Cherry Tree Rd, Chinnor  
Oxon OX9 4QY  
Tel: 01844-351694 Fax: 01844-352554  
Email: enquiries@mauritron.co.uk

### B RF ADJUSTMENT (TRACKING)

- 1 Connect RF generator to 300 ohm antenna input and detectorprobe to pin 1 IC 102 with ground to tunershield. Adjust sensitivity of oscilloscope to maximum (5mV or better) and modulate FM generator sweep  $\pm$  300 kHz or more.
- 2 Set tuner to 105 MHz, enter into preset 5, and tune generator so that curve appears on oscilloscope. Turn down RF input level so that curve covers approximately 1/2 of oscilloscope display.
- 3 Adjust C 3, C 9, C 11 and C 15 to maximum curve height while reducing RF input to keep entire curve on display.
- 4 Set tuner to 90 MHz, enter into preset 1, and tune generator so that curve appears on oscilloscope display.
- 5 Adjust L 1, L 2, L 3 and L 4 to maximum curve height.
- 6 Repeat steps 2, 3, 4 and 5 (use preset 1 and 5) until both frequencies are at maximum curve height.

NOTE: 105 MHz curveheight is typically slightly stronger than 90 MHz.

### C IF ADJUSTMENT

- 1 Set tuner to approximately 98 MHz (the tuner must be tuned to an unoccupied frequency) enter into preset 3, and tune FM generator to display a curve on oscilloscope.
- 2 Adjust L 5 and L 101 to maximum and symmetrical curve on the display, using as little input as possible.

NOTE: Maximum input 500  $\mu$ V, typical curveheight 4 mV at 150  $\mu$ V and 15 mV at 300  $\mu$ V.

D DETECTOR COARSE ADJUSTMENT (OPTIONAL, NEEDED ONLY IF DETECTOR WAS REPAIRED)

- 1 Reduce sweep modulation level to  $\pm 75$  kHz and set input level to  $300 \mu\text{V}$ .
- 2 Adjust FM generator frequency so that both legs of the inverted U-shaped curve are equally high on the display. The curve should be almost perfectly symmetrical.
- 3 Disconnect detectorprobe from tuner and oscilloscope. Connect either of the tuner outputs to the oscilloscope.
- 4 The oscilloscope should now display a diagonal line. Adjust L 102 primary (closest to IC 102) to maximum curveheight and L 102 secondary to minimum curve height and straightest possible line. Go back and forth between primary and secondary till both are peaked.

NOTE: Both the cores should be within 1.5mm from the top of the form.

E DETECTOR ALIGNMENT (FINAL)

- 1 Disconnect detectorprobe and connect tuner output to VTVM's, oscilloscope and distortion analyzer.
- 2 Switch stereo generator to 1 kHz 100% ( $\pm 75$  kHz) mono modulation and oscilloscope to normal internal sweep 0.2 mS and 0.5 V/cm sensitivity. Set tuner audio output level to 0.775 V (0 dB) on VTVM's.
- 3 Detector reference frequency.

Reduce FM generator output level while monitoring THD from left channel. When THD increases to 3%, fine tune the FM generator frequency to minimum THD. Reduce FM generator output level and fine tune till no reduction in the 3% THD can be achieved by fine tuning. Use this frequency for all the following detector, MPX and DYN SEP adjustments.

NOTE: The typical input level for this 3% THD should be  $1.6 \mu\text{V}$  to  $2.3 \mu\text{V}$ . This is done only to "line up" the frequency from the generator to the tuner's frequency.

If IHF usable sensitivity ( $-30$  dB THD + N = 3.16%) is to be verified, a proper IHF bandpass-filter must be used.

- 4 Connect DMM across TP 104 (negative) and TP 105 (positive). Set FM generator output to  $1000 \mu\text{V}$
- 5 Adjust L 102 primary (closest to IC 102) for 0 V on DMM.  
TOLERANCE  $\pm 50$  mV
- 6 Adjust L 102 secondary for lowest THD.  
SPECIFICATION less than 0.1%
- 7 Repeat steps 3, 5 and 6 till no further improvements. Record the DMM's final reading for use later in the adjustments. (I - 3)

F MUTE, AUTOSEARCH LEVEL.

- 1 Depress mute search.
- 2 Increase FM generator output upwards from 0 and adjust R 107 "MUTE" so that audio starts appearing at  $10 \mu\text{V}$  input.

TOLERANCE  $\pm 2 \mu\text{V}$ .

- 3 Release MUTE switch.

For Service Manuals Contact  
MAURITRON TECHNICAL SERVICES  
8 Cherry Tree Rd, Chinnor  
Oxon OX9 4QY  
Tel:- 01844-351694 Fax:- 01844-352554  
Email:- enquiries@mauritron.co.uk

G STEREO DECODER, MPX FILTERS.

- 1 VCO  
Connect a frequency counter and a 200 k ohm resistor in parallel between ground and TP 108.
- 2 Set FM generator to  $1000 \mu\text{V}$  output and no modulation.
- 3 Adjust R 164 "MPX VCO" for a 19000 Hz reading on the counter.  
TOLERANCE  $\pm 100$  Hz
- 4 Disconnect frequency counter and resistor and depress DYN SEP defeat switch (in).
- 5 Stereo switch threshold.  
Modulate FM generator 1 kHz 100% left only plus 19 kHz pilot 8 - 10%.



- 6 Increase FM generator level upwards from 0 and adjust R 167 "ST SW" so that stereo light turns on and audio outputs, as watched on VTVM's and oscilloscope, switches to one channel only at 10  $\mu\text{V}$  input level.

TOLERANCE + 5  $\mu\text{V}$

NOTE: When turning input level down the unit will switch into mono at a lower level, typically 7  $\mu\text{V}$ .

7 Stereo separation.

Set FM generator output to 1000  $\mu\text{V}$ , modulate left channel only.

- 8 Adjust R 158 for minimum on right channel VTVM.

- 9 Modulate FM generator right channel only and adjust R 158 for minimum on left channel VTVM.

- 10 If the minimum in step 8 and 9 are different, adjust R 158 so that the readings are the same in both channels.

SPECIFICATION better than 50 dB separation

11 MPX filter

Turn off audiomodulation, leaving pilot tone only. Disable IHF filter, or external 19 kHz filter.

- 12 Check 19/38 kHz suppression.

SPECIFICATION more than 60 dB

- 13 If unit does not meet specification adjust FL 102 "MPX FILTER" on left channel and FL 103 "MPX FILTER" on right channel to minimum output.

NOTE: DO NOT ADJUST THE MPX FILTERS UNLESS NECESSARY, the cores are brittle and break easily.

- 14 Release the DYN SEP DEFEAT switch (out).

H

DYN SEP ADJUSTMENTS.

- 1 Turn R 256 "DYN SEP OFF", R 249 and 250 "DYN SEP" fully clockwise.

- 2 DYN SEP separation effect.

Observe output from left channel with FM generator output level 1000  $\mu\text{V}$  and modulated 1 kHz left channel only.

Reduce audiomodulation only from stereo generator so that left channel output is reduced by 6 dB (50% stereo modulation).

The 19 kHz pilot signal MUST REMAIN modulated 8 - 10%.

- 3 Set FM generator output to 50  $\mu\text{V}$  and adjust R 249 "DYN SEP" for -30 dB separation left to right channel.

TOLERANCE  $\pm 2$  dB

- 4 Switch modulation to right channel only while maintaining the same modulation levels.

Adjust R 250 "DYN SEP" for -30 dB separation right to left channel.

TOLERANCE  $\pm 2$  dB

5 DYN SEP auto defeat level.

Set generator output to 200  $\mu\text{V}$  and adjust R 256 "DYN SEP OFF" so that separation starts increasing when watching left channel VTVM. Adjust FM generator output up and down around 200  $\mu\text{V}$  and make sure switching occurs around 200  $\mu\text{V}$ .

TOLERANCE + 100  $\mu\text{V}$  - 30  $\mu\text{V}$

I

SYNTHESIZER FREQUENCY

- 1 Tune to a known accurate frequency source, i.e., broadcasting station or synthesized/digital display FM generator preferably in the midband 95 - 100 MHz.

- 2 Connect DMM across TP 104 (negative) and TP 105 (positive).

- 3 Adjust C 209 "FQ" so that DMM reads the same as recorded in E - 7.

TOLERANCE  $\pm 10$  mV

For Service Manuals Contact  
MAURITRON TECHNICAL SERVICES  
8 Cherry Tree Rd, Chinnor  
Oxon OX9 4QY  
Tel:- 01844-351694 Fax:- 01844-352554  
Email:- enquiries@mauritron.co.uk

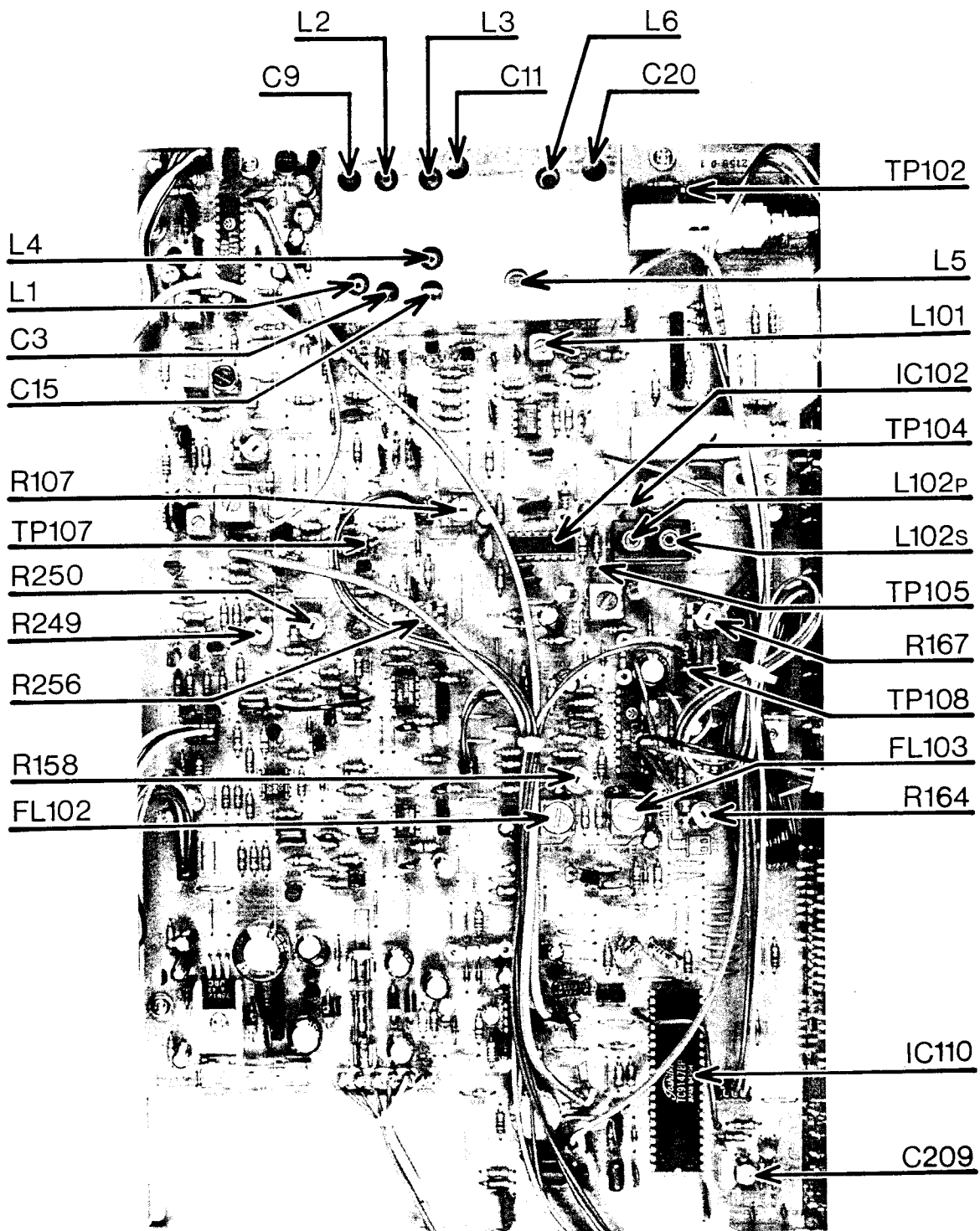

For Service Manuals Contact  
**MAURITRON TECHNICAL SERVICES**  
 8 Cherry Tree Rd, Chinnor  
 Oxon OX9 4QY  
 Tel:- 01844-351694 Fax:- 01844-352554  
 Email:- enquiries@mauritron.co.uk

# AM ALIGNMENTS

## A OSCILLATOR.

- 1 Connect DMM to TP 101 and gnd.
- 2 Tune to 1710 kHz. Enter into preset 1. Adjust C 148 for reading of  $31 \pm 0.5\text{VDC}$ .
- 3 Tune to 520 kHz. Enter into preset 2. Adjust L 103 for reading of  $1.8 \pm 0.1\text{ VDC}$ .
- 4 Repeat steps 2 and 3 until within tolerances.

## B ANTENNA, IF

- 1 Swing antenna away from chassis and peel back label (if present) to expose adjustment tab.
- 2 Connect DC voltmeter to centertap, R 208 and gnd.
- 3 Tune to station of moderate strength, near 600 kHz. Enter into preset 3. Adjust L 951 (move tab under label on antenna) for maximum reading on meter. (Use non-interactive tool, such as plastic or wooden stick.)
- 4 Adjust L 104 and L 106 for maximum reading on meter.
- 5 Tune station of moderate strength near 1400 kHz. Enter into preset 4. Adjust C 147 for maximum reading on meter.
- 6 Repeat steps 3 and 5 until no further improvement is seen.

## C 9 kHz, 10 kHz WHISTLE FILTERS

- 1 Tune to quiet spot on the dial (a clear frequency)
- 2 Connect audio osc. to base, Q 117 (isolate with 0.1 - 1.0  $\mu\text{F}$  capa.)
- 3 Connect AC VTVM (or scope) to TP 103.
- 4 Set audio osc. to 10 kHz ( $\pm 50\text{ Hz}$ ) 1 V. Adjust FL 104 for minimum meter reading.
- 5 Set audio osc. to 9 kHz ( $\pm 50\text{ Hz}$ ) 1 V. Adjust FL 105 for minimum meter reading.

## D SIGNAL METER, AUTO STOP

R 208 controls signal strength indication and auto stop level, adjust only if necessary, to correct for scan stopping on excessively weak signals, or failure to stop on moderately strong ones.

NOTE: When finished, lock antenna bar adjustment with laquer (nail polish), re-install label.

**For Service Manuals Contact**  
**MAURITRON TECHNICAL SERVICES**  
8 Cherry Tree Rd, Chinnor  
Oxon OX9 4QY  
Tel:- 01844-351694 Fax:- 01844-352554  
Email:- enquiries@mauritron.co.uk

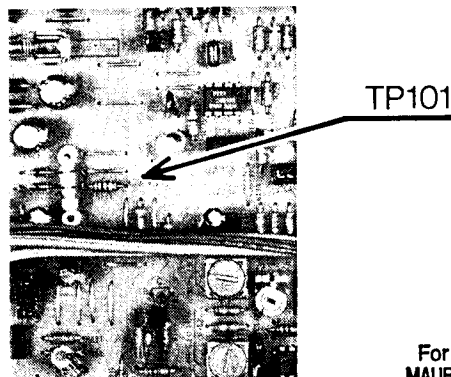
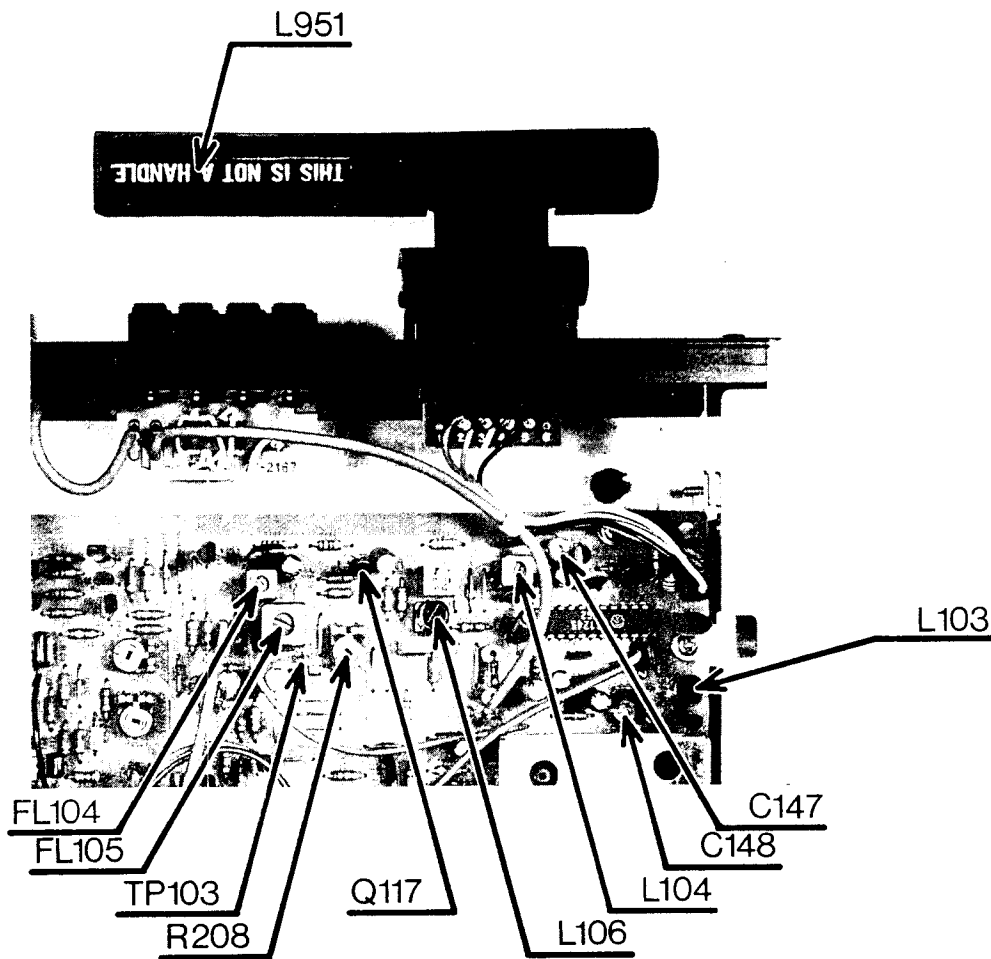

For Service Manuals Contact  
**MAURITRON TECHNICAL SERVICES**  
 8 Cherry Tree Rd, Chinnor  
 Oxon OX9 4QY  
 Tel:- 01844-351694 Fax:- 01844-352554  
 Email:- enquiries@mauritron.co.uk

# WIRING DIAGRAM

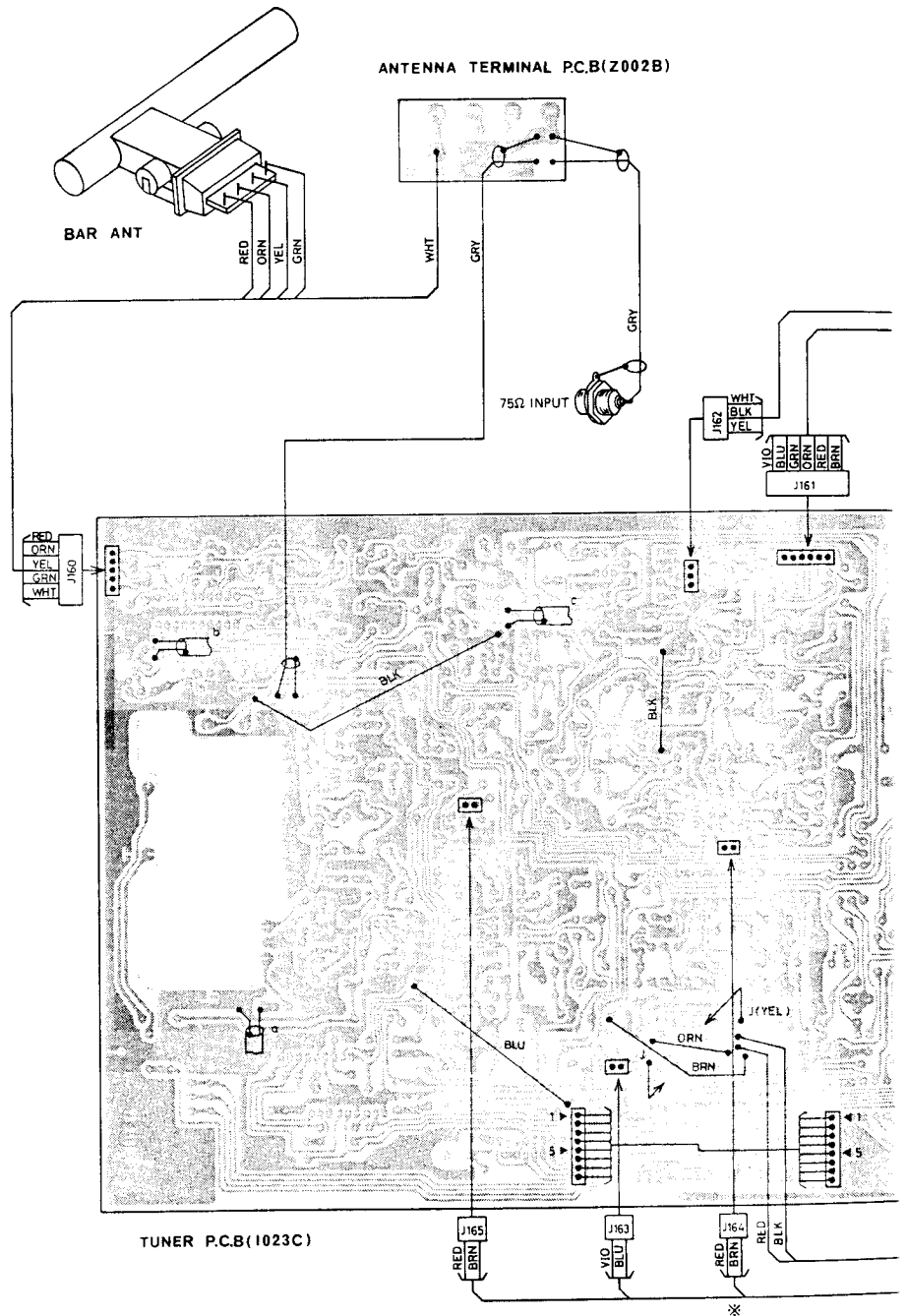

For Service Manuals Contact  
**MAURITRON TECHNICAL SERVICES**  
 8 Cherry Tree Rd, Chinnor  
 Oxon OX9 4QY  
 Tel:- 01844-351694 Fax:- 01844-352554  
 Email:- enquiries@mauritron.co.uk

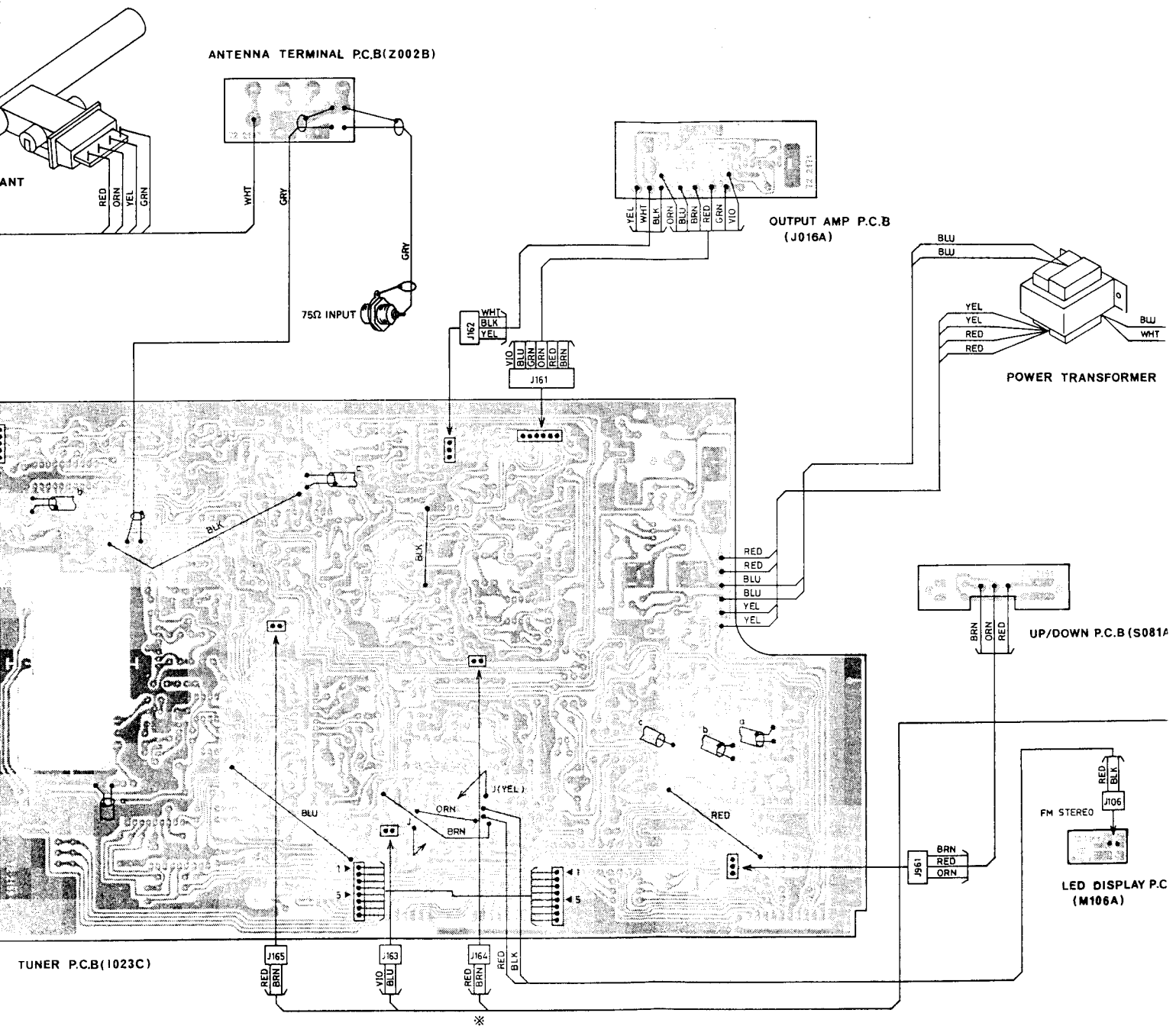

For Service Manuals Contact  
**MAURITRON TECHNICAL SERVICES**  
 8 Cherry Tree Rd, Chinnor  
 Oxon OX9 4QY  
 Tel: 01844-351694 Fax: 01844-352554  
 Email: enquiries@mauritron.co.uk

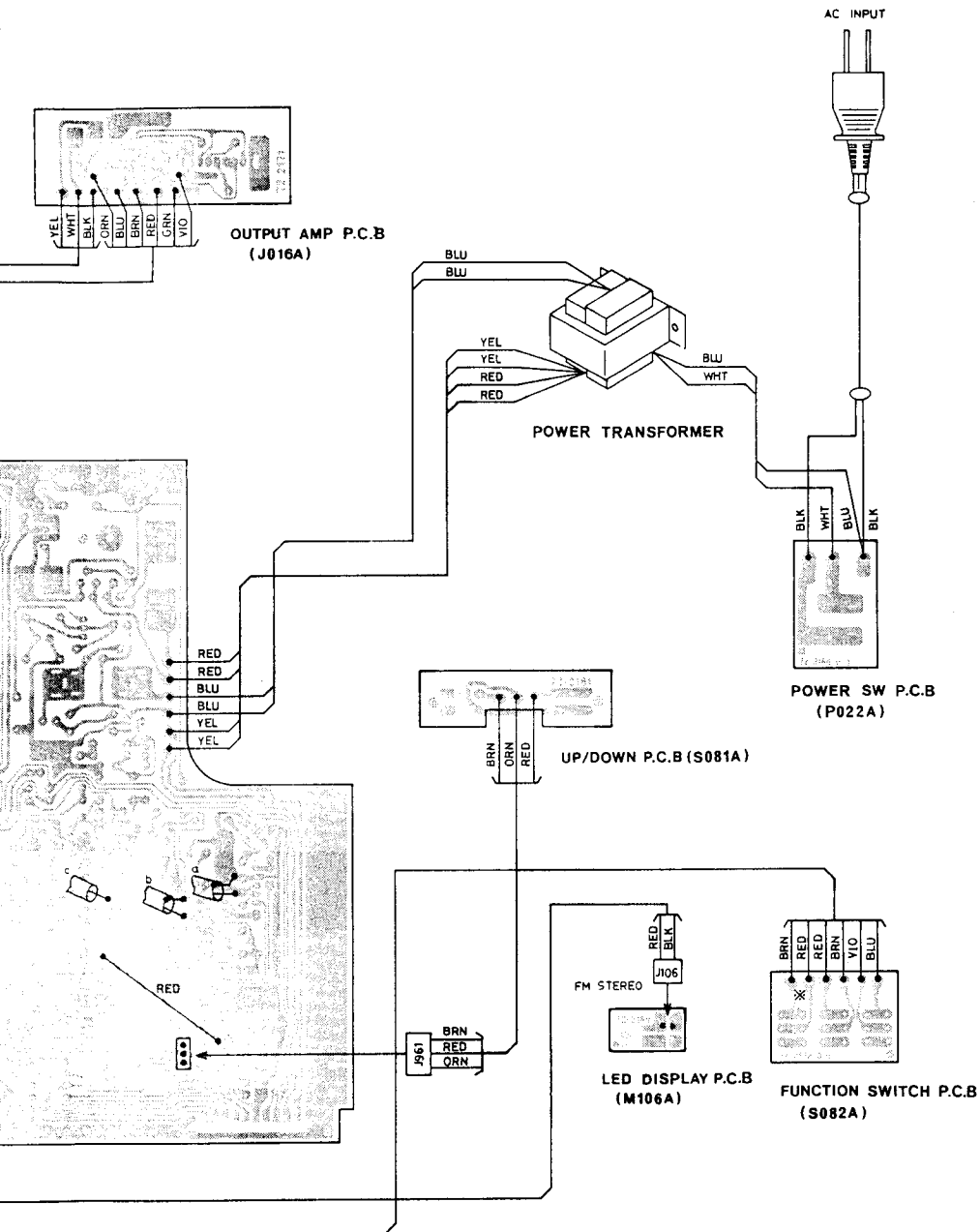

For Service Manuals Contact  
**MAURITRON TECHNICAL SERVICES**  
 8 Cherry Tree Rd, Chinnor  
 Oxon OX9 4QY  
 Tel: 01844-351694 Fax: 01844-352554  
 Email: enquiries@mauritron.co.uk

# P.C.B. LAYOUT DIAGRAM

ANTENNA TERMINAL PCB

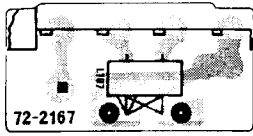

OUTPUT AMP. PCB

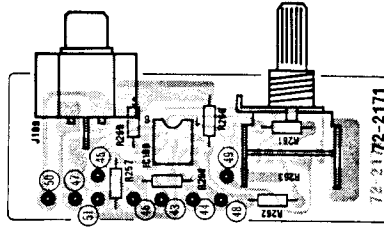

TUNER PCB

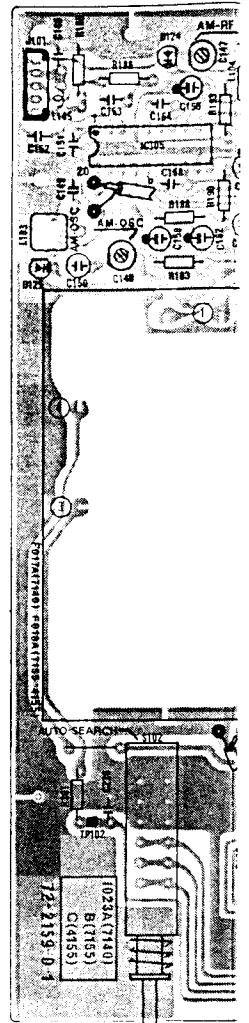

LED DISPLAY PCB



For Service Manuals Contact  
**MAURITRON TECHNICAL SERVICES**  
 8 Cherry Tree Rd, Chinnor  
 Oxon OX9 4QY  
 Tel:- 01844-351694 Fax:- 01844-352554  
 Email:- enquiries@mauritron.co.uk

FRONTEND PCB

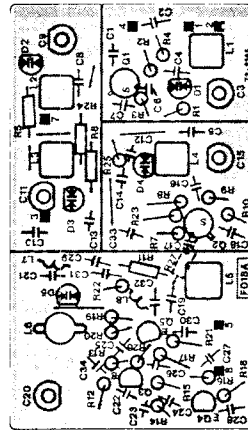

UP/DOWN PCB

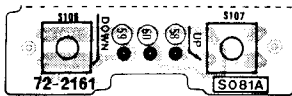

POWER SWITCH PCB

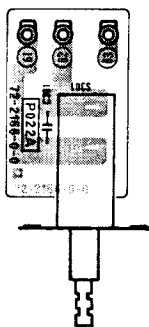

FUNCTION SWITCH PCB

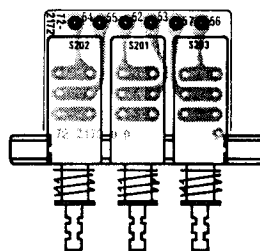

DISPLAY & PRE

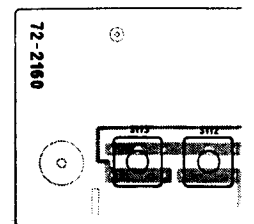



TUNER PCB

OUTPUT AMP. PCB

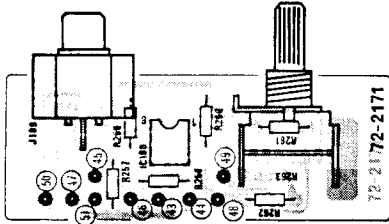

FRONTEND PCB

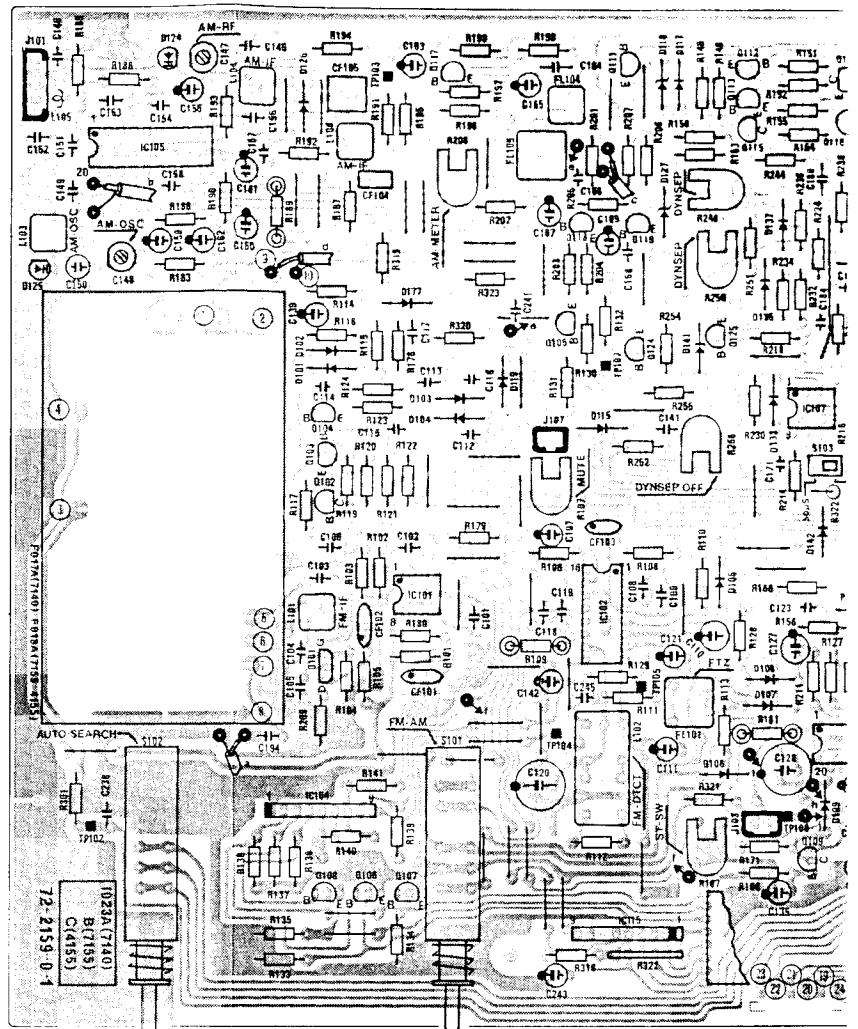
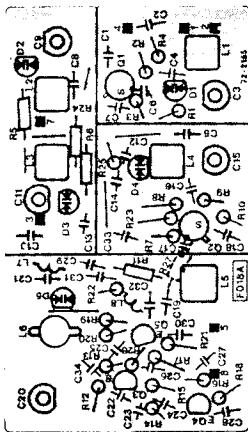

FUNCTION SWITCH PCB

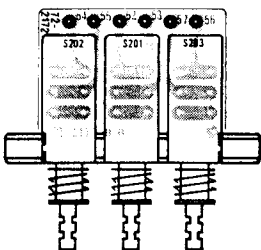

DISPLAY & PRESET SELECTOR PCB

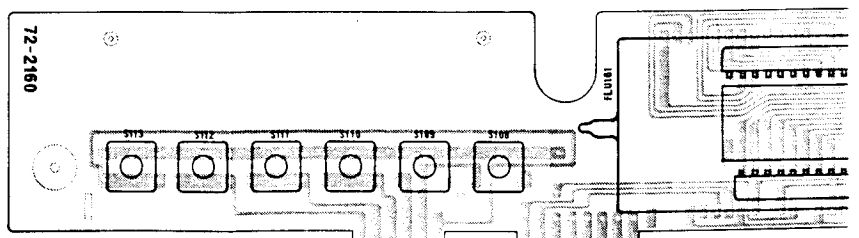

For Service Manuals Contact  
**MAURITRON TECHNICAL SERVICES**  
 8 Cherry Tree Rd, Chinnor  
 Oxon OX9 4QY  
 Tel:- 01844-351694 Fax:- 01844-352554  
 Email:- enquiries@mauritron.co.uk

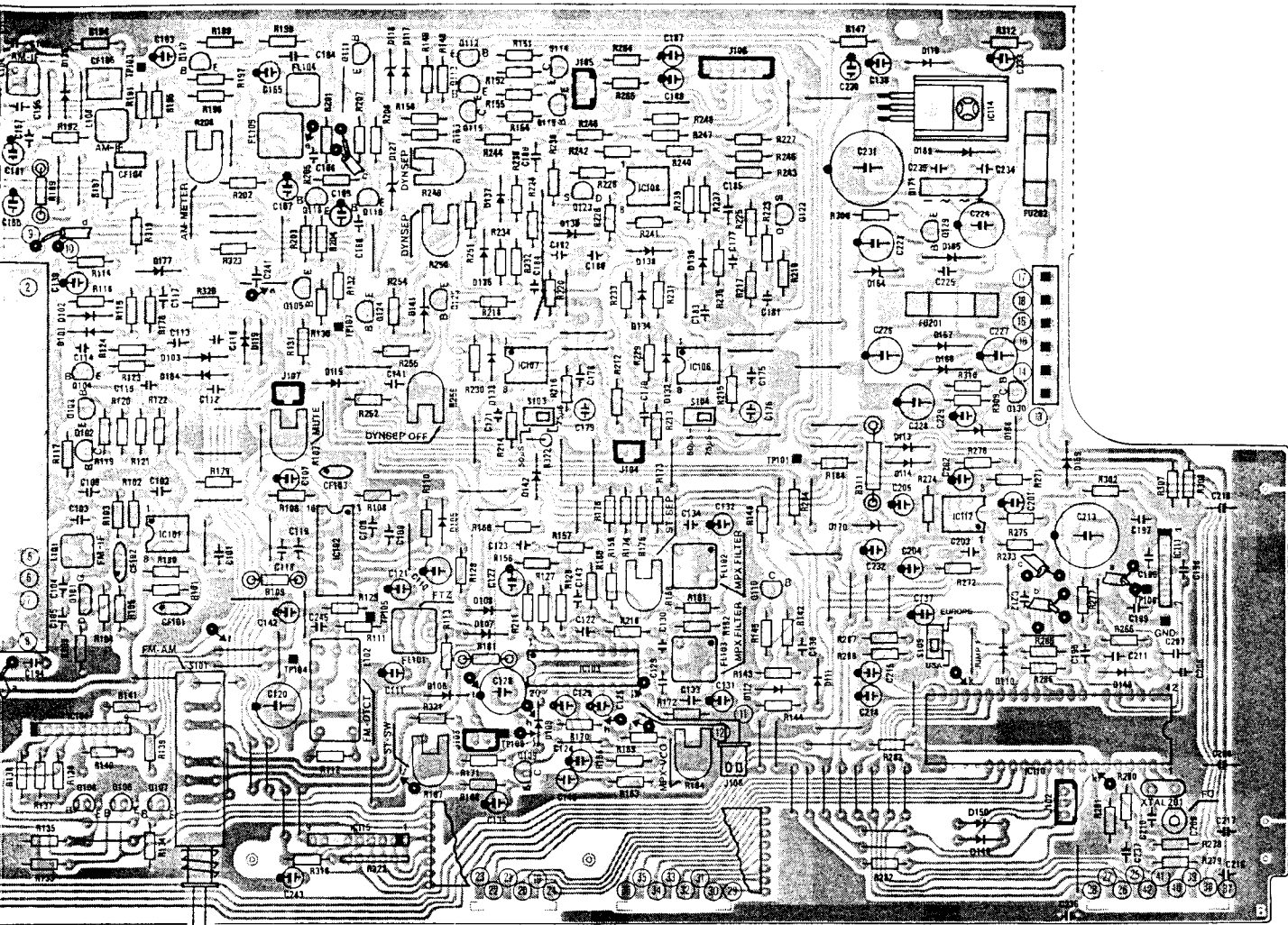

For Service Manuals Contact  
**MAURITRON TECHNICAL SERVICES**  
 8 Cherry Tree Rd, Chinnor  
 Oxon OX9 4QY  
 Tel:- 01844-351694 Fax:- 01844-352554  
 Email:- enquiries@mauritron.co.uk

**RESET SELECTOR PCB**

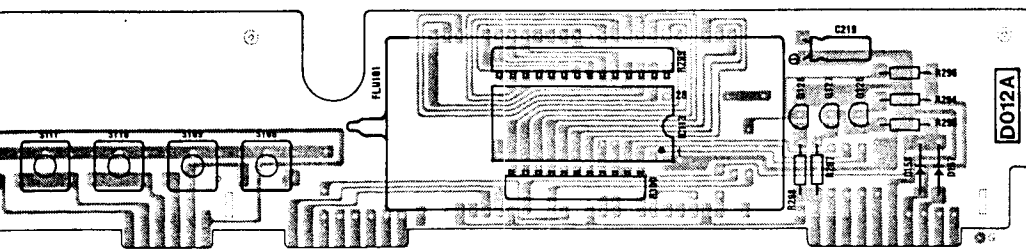

# SCHEMATIC DIAGRAM NAD 4155 TUNER

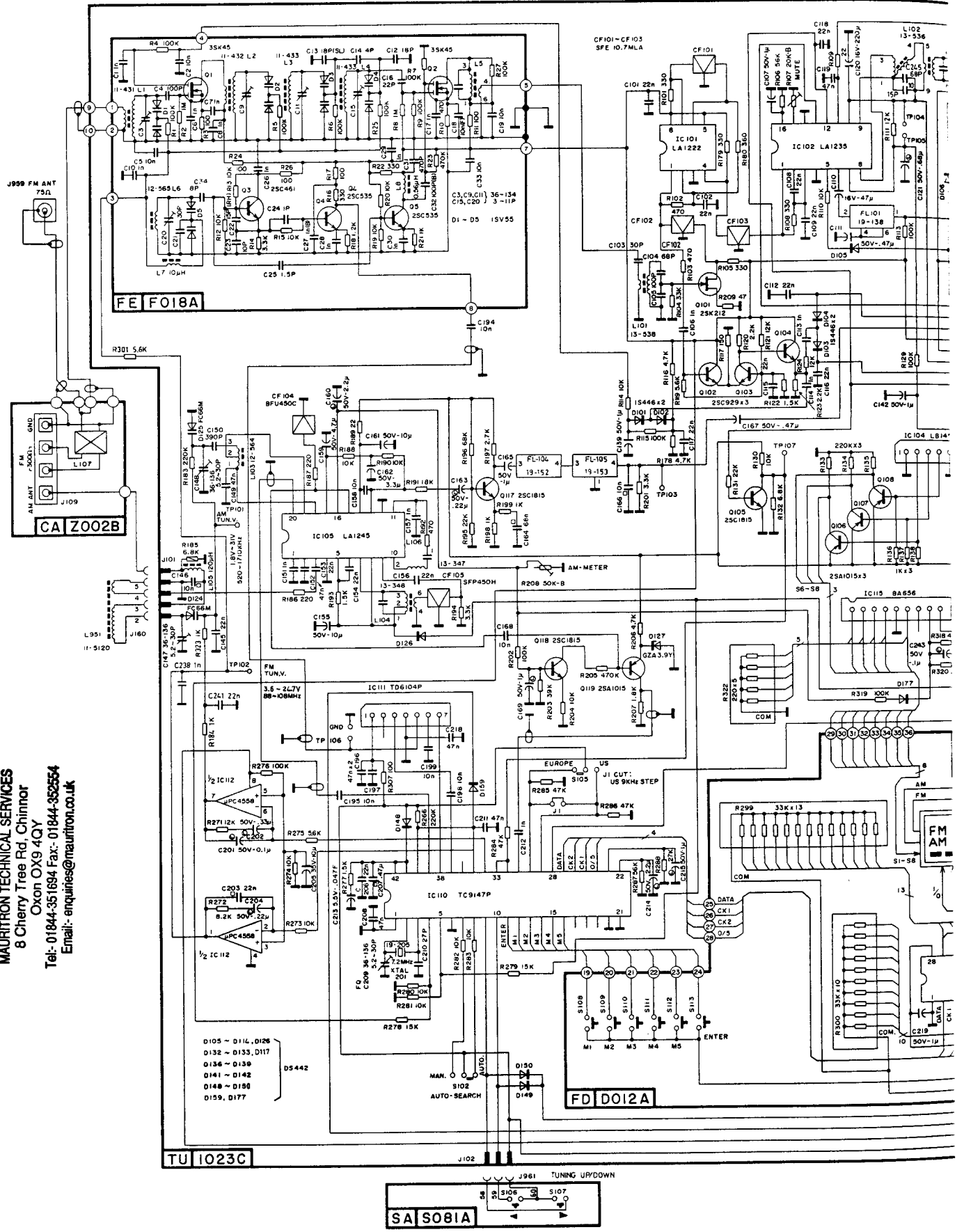

LD M106A 2351 374400 STEREO IND

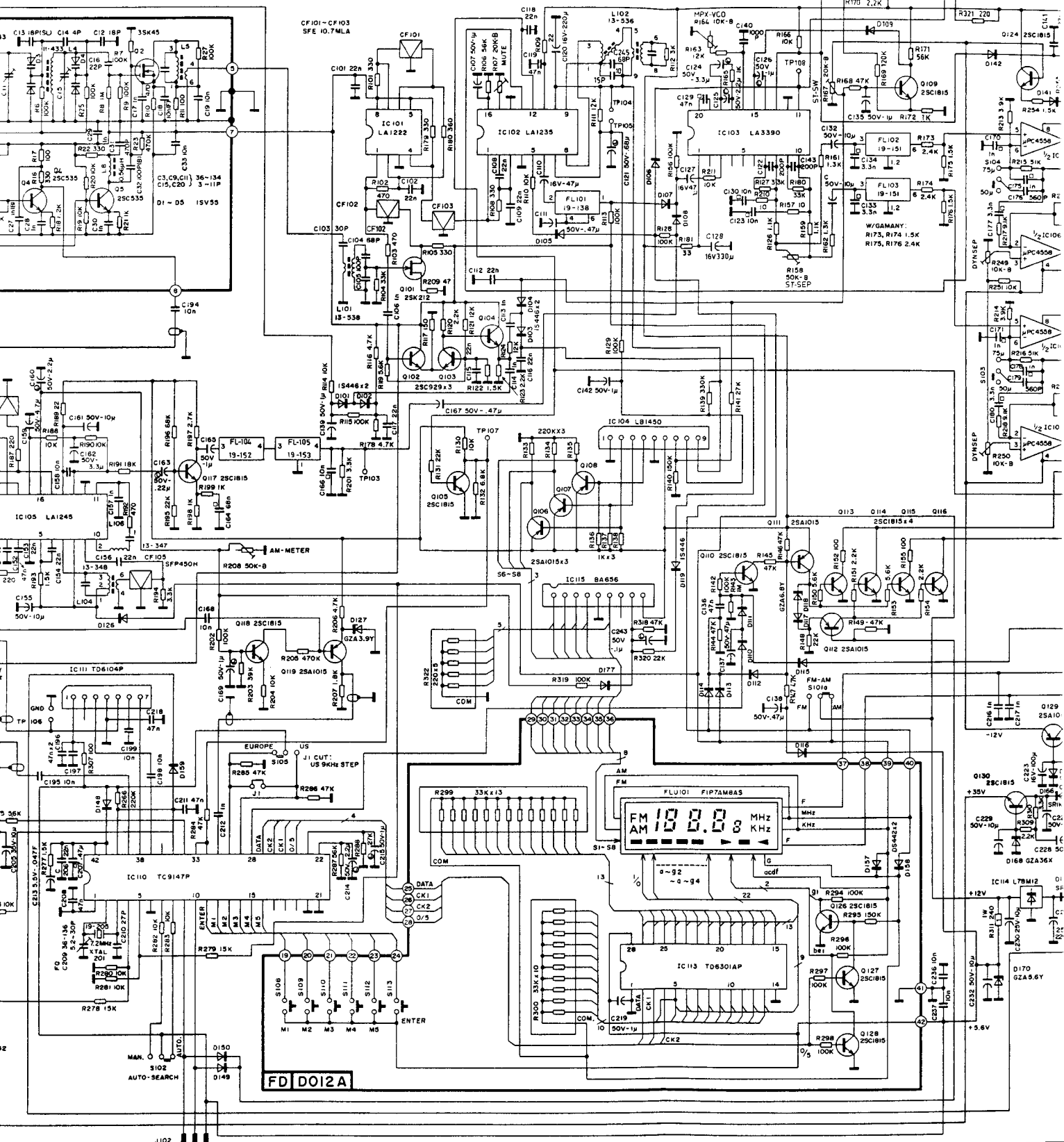

SA S0B1A

For Service Manuals Contact  
**MAURITRON TECHNICAL SERVICES**  
 8 Cherry Tree Rd, Chinnor  
 Oxon OX9 4QY  
 Tel: 01294-351694 Fax: 01244-355554  
 Email: [enquiries@maurtron.co.uk](mailto:enquiries@maurtron.co.uk)

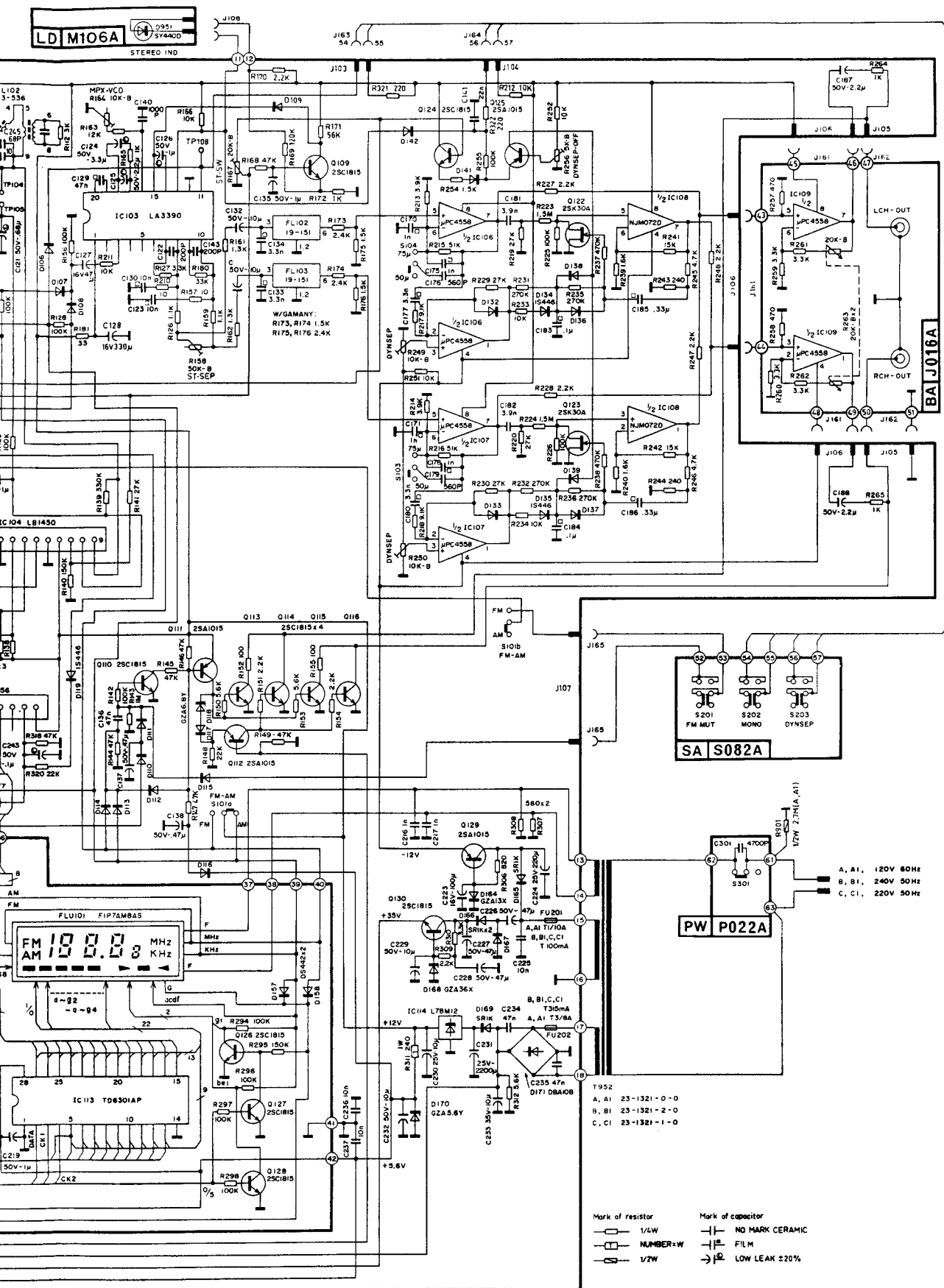

For Service Manuals Contact  
**MAURITRON TECHNICAL SERVICES**  
 8 Cherry Tree Rd, Chinnor  
 Oxon OX9 4QY  
 Tel: 01844-351894 Fax: 01844-352554  
 Email: enquiries@mauritron.co.uk

# EXPLODED VIEW PARTS LIST

Ref. No.	Parts No.	Descriptions
1	63-6274-0-0	FRONT PANEL
2	62-1105-0-0	PUSH BUTTON - SELECTORS
3	62-1105-1-0	PUSH BUTTON - ON/OFF
4	62-3465-0-0	PUSH BUTTON FRAME - SINGLE HOLE
5	62-3467-0-0	PUSH BUTTON FRAME - 3 HOLES
6	62-3469-1-0	DISPLAY PANEL
7	62-1106-0-0	PUSH BUTTON - BLACK
8	62-1106-1-0	PUSH BUTTON - LIGHT BROWN
9	62-3471-0-0	PUSH BUTTON PLUNGER
10	88- 170-0-0	SPRING - PUSH BUTTON RETURN
11	62-1107-0-0	ROCKER BUTTON - UP/DOWN SEARCH
12	62-1108-0-0	PUSH BUTTON - AUTO SEARCH
13	63-5169-0-0	DISPLAY WINDOW
14	92-2102-0-0	FOOT - SNAP ON TYPE
	92-2103-0-0	FOOT - PLASTIC RIVET TYPE
15	63-1844-0-0	LABEL : THIS IS NOT A HANDLE.
21	71-2595-0-0	FRONT SUBCHASSIS
22	71-2593-0-0	SIDE CHASSIS (L)
23	71-2592-0-0	SIDE CHASSIS (R)
24	71-2591-0-0	SUBCHASSIS (FRONT TO REAR SUPPORT)
25	71-2590-0-0	SUBCHASSIS (LEFT TO RIGHT SUPPORT)
26	71-2594-0-0	REAR PANEL (A A1)
	71-2599-0-0	REAR PANEL (C C1)
	71-2599-1-0	REAR PANEL (B B1)
27	71-3106-0-0	CABINET
28	71-3105-0-0	BOTTOM COVER
29	71-1892-0-0	BRACKET - OUTPUT LEVEL CONTROL
31	11-5120-0-0	AM BAR ANTENNA
32	82-2162-0-0	F TYPE ANTENNA CONNECTOR (A A1)
	82- 293-0-0	DIN TYPE ANTENNA CONNECTOR (B B1 C C1)
34	23-1321-0-0	POWER TRANSFORMER (A)
	23-1321-1-0	POWER TRANSFORMER (C C1)
	23-1321-2-0	POWER TRANSFORMER (B B1)
	23-1321-3-0	POWER TRANSFORMER (A1)
35	85- 258-0-0	POWER CORD (A A1)
	85- 235-0-0	POWER CORD (C C1)
	85- 240-0-0	POWER CORD (B)
35	85- 259-0-0	POWER CORD (B1)
36	92- 272-0-0	INSULATOR (PVC) (B B1 C C1)
37	62-3332-0-0	BUSHING - AC POWER CORD
38	63-1843-0-0	LABEL (CAUTION FOR FUSE) (A A1)
41	F018A	FM FRONTEND PCB
42	I023C	TUNER PCB
42 - 1	81-2325-0-0	PUSH SWITCH - FM/AM & AUTO/MANUAL SELECTOR
42 - 2	74- 388-0-0	HEAT SINK
42 - 3	71-1889-0-0	PCB SUPPRT
43	D012A	DISPLAY & PRESET SELECTOR PCB
43 - 1	7AM8AS	FLOURESCENT INDICATOR TUBE
43 - 2	81-2326-0-0	MOMENTARY SWITCH - PRESET & UP/DOWN
44	S081A	UP/DOWN PCB

For Service Manuals Contact  
**MAURITRON TECHNICAL SERVICES**  
 8 Cherry Tree Rd, Chinnor  
 Oxon OX9 4QY  
 Tel: 01844-351694 Fax: 01844-352554  
 Email: enquiries@mauritron.co.uk

Ref. No.	Parts No.	Descriptions
45	Z002B	ANTENNA TERMINAL PCB
45 - 1	82-2163-0-0	CONNECTORS - ANTENNA TERMINAL
46	S082A	FUNCTION SWITCH PCB
46 - 1	81-2327-0-0	FUNCTION SWITCH BANK (3 SWITCHES)
47	J016A	OUTPUT AMP PCB
47 - 1	41- 687-0-0	ROTARY POTENTIOMETER - OUTPUT LEVEL CONTROL
47 - 2	82-2130-0-0	RCA CONNECTORS - SINGLE
48	M106A	LED DISPLAY PCB
49	P022A	POWER SWITCH PCB
49 - 1	81-2320-0-0	POWER SWITCH
51		TAPPING SCREW (PHILLIP'S HEAD 3 x 6 BLK)
52		TAPPING SCREW (PHILLIP'S HEAD 3 x 8 BLK)
53		MACHINE SCREW (PHILLIP'S HEAD 3 x 6 BLK)
54		TAPPING SCREW (PHILLIP'S HEAD 3 x 6 Cr)
55		TAPPING SCREW (WASHER HEAD 3 x 6 Cr)
56		MACHINE SCREW (PAN 3 x 6 Cr)
57		MACHINE SCREW S (WASHER HEAD 3 x 6 Cr)
58		TAPPING SCREW (PAN 2.6 x 6 Cr)
59		TAPPING SCREW (PHILLIP'S HEAD 3 x 8 Cr)
60		CABINET SCREW WITH WASHER (4 x 6 BLK)
61		TERMINAL LUG (3 Ni) (A A1)
62		WASHER (TOOTHED LOCK B 3 Ni)
63		OUTPUT CONTROL NUT (HEXAGON 9-11-2)
64		WASHER (PLAIN 9-15-0.5)
65		F-CONNECTOR NUT (HEXAGON UNF3/8-11-2)
66		TERMINAL LUG (MET31-0107)

**For Service Manuals Contact**  
**MAURITRON TECHNICAL SERVICES**  
**8 Cherry Tree Rd, Chinnor**  
**Oxon OX9 4QY**  
**Tel:- 01844-351694 Fax:- 01844-352554**  
**Email:- enquiries@mauritron.co.uk**

# EXPLODED VIEW

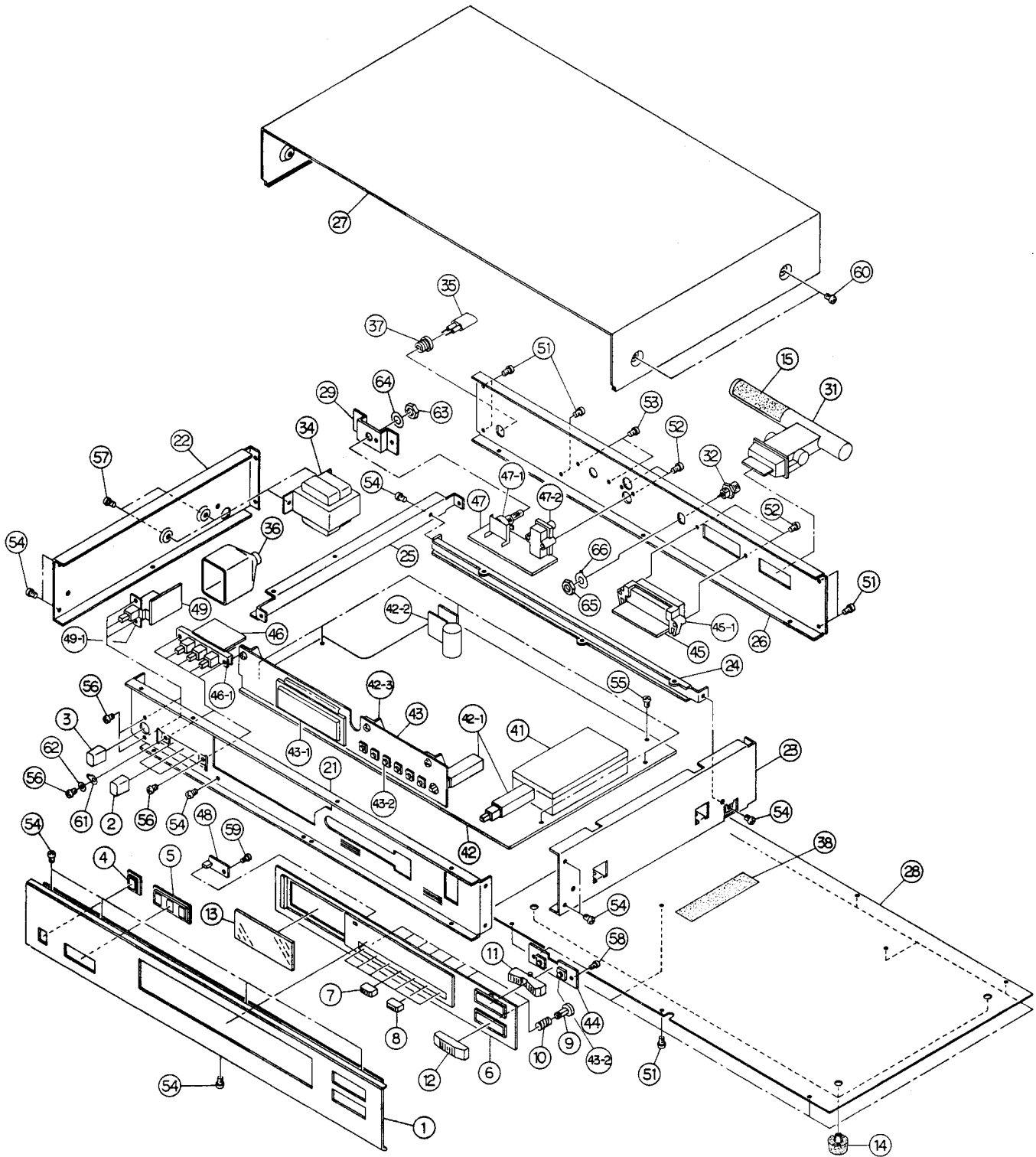

For Service Manuals Contact  
**MAURITRON TECHNICAL SERVICES**  
8 Cherry Tree Rd, Chinnor  
Oxon OX9 4QY  
Tel: 01844-351694 Fax: 01844-352554  
Email: enquiries@mauritron.co.uk



# ELECTRICAL PARTS LIST

NOTE: This is not a complete electrical parts list.

## FRONTEND P.C.B.: F018A (EXPLODED VIEW REF. NO.41)

SYMBOL NO.	PARTS NO.	DESCRIPTIONS
Q1, Q2	3SK45(B)	F.E.T.
Q3	2SC461(B)	TRANSISTOR
Q4, Q5	2SC535(B)	TRANSISTOR
D1 - D5	1SV55	DIODE, VARIABLE CAPACITANCE
L1	11-431	FM ANTENNA COIL
L2	11-432	FM RF COIL
L3, L4	11-433	FM RF COIL
L5	13-533	IFT COIL
L6	12-565	OSC COIL
L7	10 $\mu$ H	CHOKER COIL
L8	0.56 $\mu$ H	CHOKER COIL
C3, C9, C11, C15, C20	36-134	TRIMMER CAPACITOR, 3 - 11pF
C21	50V, 30pF, J, RH	CERAMIC CAPACITOR
C22	50V, 15pF, J, RH	"
C23	50V, 10pF $\pm$ 0.5pF, RH	"
C24	50V, 1pF $\pm$ 0.25pF, CK	"
C25	50V, 1.5pF $\pm$ 0.25pF, CK	"
C34	50V, 8pF $\pm$ 0.5pF, CH	"

## TUNER P.C.B. : I023C (EXPLODED VIEW REF. NO.42)

SYMBOL NO.	PARTS NO.	DESCRIPTIONS
IC101	LA1222	INTEGRATED CIRCUIT
IC102	LA1235	"
IC103	LA3390	"
IC104	LB1450	"
IC105	LA1245	"
IC106, IC107, IC,122	$\mu$ PC4558	"
IC108	NJM072D	"
IC110	TC9157P	"
IC111	TD6104P	"
IC114	L78M12	"
IC115	BA656	"
Q101	2SK212(E)	F.E.T.
Q102 - Q104	2SC929(E)	TRANSISTOR
Q105, Q109, Q110	2SC1815(Y,GR)	"
Q113 - Q118, Q124	"	"
Q130	"	"
Q106 Q108, Q111	2SA1015(Y, GR)	"
Q112, Q119, Q125	"	"
Q129	"	"
Q122, Q123	2SK30A(GR)	F.E.T.
D101 - D104, D119	1S446	DIODE
D134, D135	"	"
D105 - D114, D126	DS442BT	"
D132, D133, D136 - D139	"	"
D141, D142, D148 - D151	"	"
D159, D177	"	"

For Service Manuals Contact  
**MAURITRON TECHNICAL SERVICES**  
 8 Cherry Tree Rd, Chinnor  
 Oxon OX9 4QY  
 Tel: 01844-351694 Fax: 01844-352554  
 Email: enquiries@mauratron.co.uk

SYMBOL NO.	PARTS NO.	DESCRIPTIONS
D118	GZA6.8Y	ZENER DIODE
D127	GZA3.9Y	"
D164	GZA13X	"
D168	GZA36X	"
D170	GZA5.6Y	"
D124, D125	FC66M	VARACTOR DIODE
D165 - D167, D169	SR-1K	RECTIFIER
D171	DBA10B	"
L101	13-538	IFT COIL
L102	13-536	FM DETECTOR COIL
L103	12-564	AM OSCILLATOR COIL
L104	13-348	450KHz MATCHING COIL
L105	15-167	CHOKO COIL, 120 $\mu$ H
L106	13-347	IFT COIL
FL101	19-138	ANTIBIRDY FILTER
FL102, FL103	19-151	LOW PASS FILTER
FL104	19-152	"
FL105	19-153	"
CF101 - CF103	19-154	CERAMIC FILTER
CF104	19-136	"
CF105	19-140	"
C104	50V, 68pF, J, RH	CERAMIC CAPACITOR
C105	50V, 100pF, J, RH	"
C121	50V, 0.68 $\mu$ F	ELECTROLYTIC CAPACITOR, LOW LEAKAGE
C124	50V, 3.3 $\mu$ F	" " "
C125, C160, C214	50V, 2.2 $\mu$ F	" " "
C126, C169, C215	50V, 1 $\mu$ F	" " "
C147, C148, C209	36-136	TRIMMER CAPACITOR, 5.2 - 30pF
C163, C204	50V, 0.22 $\mu$ F	ELECTROLYTIC CAPACITOR, LOW LEAKAGE
C201, C243	50V, 0.1 $\mu$ F	" " "
C202	50V, 0.33 $\mu$ F	" " "
C213	5.5V, 0.047 $\mu$ F	MEMORY BACKUP CAPACITOR
C245	50V, 68pF, J, COG } 50V, 15pF, J, RH }	CERAMIC CAPACITOR "
R107, R167	20K $\Omega$ , B	VARIABLE RESISTOR
R158, R208	50K $\Omega$ , B	"
R164, R249, R250	10K $\Omega$ , B	"
R185	6.8K $\Omega$ , 1/2W	CARBON RESISTOR
R256	5K $\Omega$ , B	VARIABLE RESISTOR
R311	240 $\Omega$ , 1W	OXIDE METAL RESISTOR, RSF1B
R322	220K $\Omega$ x 5	RESISTOR ARRAY
XTAL201	19-205	CRYSTAL, 7.2MHz
S103, S104	81-451	DEEMPHASIS, SLIDE SWITCH
S105	"	9/10KHz, "
FU201	MDL1/10 100mA	FUSE, 250V, 1/10A (A VERSION) FUSE, 250V, 100mA (B, C VERSION)
FU202	MDL3/8 315mA	FUSE, 250V, 3/8A (A VERSION) FUSE, 250V, 315mA (B, C VERSION)

For Service Manuals Contact  
**MAURITRON TECHNICAL SERVICES**  
8 Cherry Tree Rd, Chinnor  
Oxon OX9 4QY  
Tel: 01844-351694 Fax: 01844-352554  
Email: enquiries@mauritron.co.uk

DISPLAY & PRESET SELECTOR P.C.B.: D012A (EXPLODED VIEW REF. NO.43)

SYMBOL NO.	PARTS NO.	DESCRIPTIONS
IC113	TD6301AP	INTEGRATED CIRCUIT
Q126 - 128	2SC1815	TRANSISTOR
D157, D158	DS442	DIODE
R229 R300	33K $\Omega$ x 13 33K $\Omega$ x 10	RESISTOR ARRAY "
FLU101	7AM8AS	FL INDICATOR

ANTENNA TERMINAL P.C.B.: Z002B (EXPLODED VIEW REF. NO.45)

SYMBOL NO.	PARTS NO.	DESCRIPTIONS
L107	11-419	BALUN TRANSFORMER

OUTPUT AMP. P.C.B.: J016A (EXPLODED VIEW REF. NO. 47)

SYMBOL NO.	PARTS NO.	DESCRIPTIONS
IC109	$\mu$ PC4558	INTEGRATED CIRCUIT
R263	41-687	POTENTIOMETER, 20KB x 2.

POWER SWITCH P.C.B.: P022A (EXPLODED VIEW REF. NO.49)

SYMBOL NO.	PARTS NO.	DESCRIPTIONS
C952	DE7100FZ	CERAMIC CAPACITOR

LED DISPLAY P.C.B.: M106A (EXPLODED VIEW REF. NO.48)

SYMBOL NO.	PARTS NO.	DESCRIPTIONS
D951	SY440D	L.E.D., FM STEREO

**For Service Manuals Contact**  
**MAURITRON TECHNICAL SERVICES**  
8 Cherry Tree Rd, Chinnor  
Oxon OX9 4QY  
Tel:- 01844-351694 Fax:- 01844-352554  
Email:- enquiries@mauritron.co.uk